

WOLGRAM
 Engineered Plastics, LLC.
www.wolgrammfg.com
 866-WOLGRAM

PART NUMBER **MC-12A**
 8.5 x 14 x 1.75 Aluminum Enclosure.
 Black Anodized

Unless otherwise specified, dimensions are in inches. Information in this drawing is provided for reference only.

5

4

3

2

1

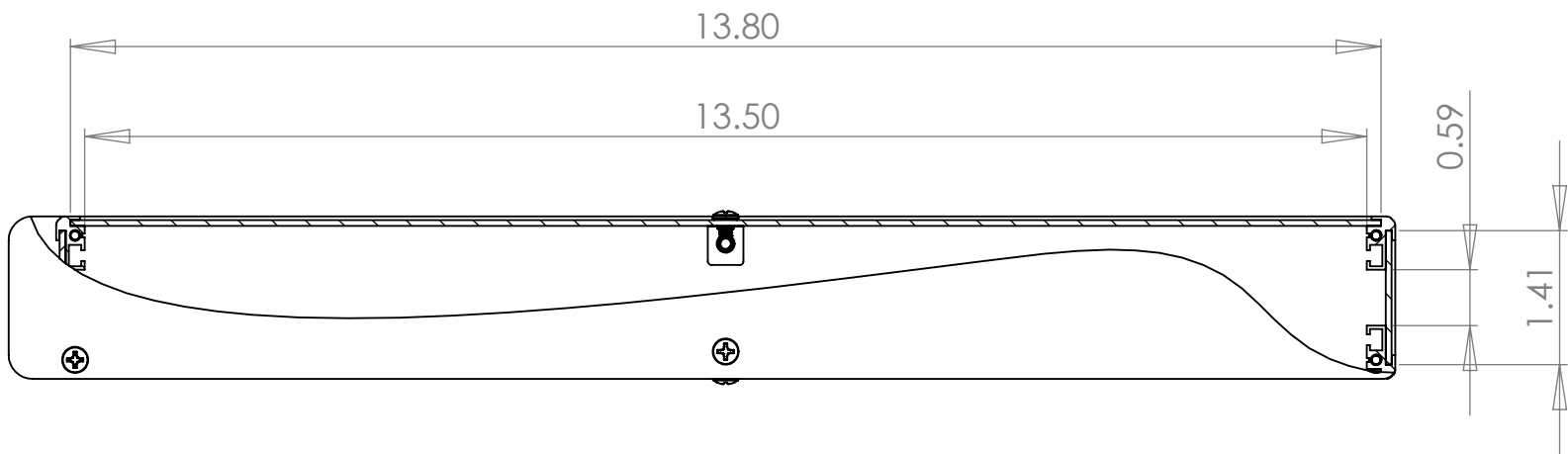

WOLGRAM
 Engineered Plastics, LLC.
www.wolgrammfg.com
 866-WOLGRAM

PART NUMBER **MC-12A**
 8.5 x 14 x 1.75 Aluminum Enclosure.
 Black Anodized

Unless otherwise specified, dimensions are in inches. Information in this drawing is provided for reference only.